

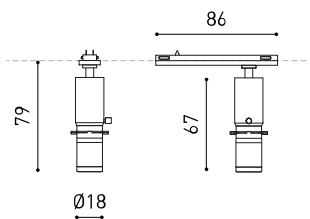

## Dimensiones



## Accesorios



MINIMAL TRACK OPTIONS

Nombre	MICRO SHAPER 24V 18°-34° 2700K N
Referencia	A5440000N
Color	Negro
RAL	Anodizado, baño de color, similar a RAL 9005
Categoría	TRACK LIGHTS

Tipo	LED
Flujo luminoso	190 lm
Temperatura de color	2700 K - Otros K, consultar
Estabilidad cromática	MacAdam Step 3
Índice de reproducción cromática	CRI > 90
Potencia	2,2 W
Corriente	700 mA
Eficacia	86 lm/W
Horas de vida del LED	L90B10 > 102.000h
Eficiencia energética	F

Eficiencia lumínica	19-27%
Ángulo del haz de luz	18°-34°

Potencia del sistema	3,01 W
Tensión	24Vdc
Regulación	Opciones DIM
Clase de seguridad eléctrica	⚡

Estanqueidad	IP20
Control inalámbrico	Consultar
Ángulo de basculación	90°
Ángulo de giro	355°
Tipo de carril	Minimal Track
Peso	55 g
Peso con embalaje	105 g
Dimensiones embalaje	119 x 117 x 57 mm
Unidades por embalaje	1
Materiales	Aluminio / Cristal Óptico

## PRODUCTO

## FUENTE DE LUZ

## LUMINARIA | DATOS FOTOMÉTRICOS

## LUMINARIA | DATOS ELÉCTRICOS

## OTROS DATOS



En un ejercicio de miniaturización insólita, el perfilador Micro Shaper nace para definir y proyectar la luz con precisión, versatilidad y máxima atención por el detalle. Su funcionamiento se basa en la refracción sucesiva de la luz a través de un conjunto de lentes, asegurando la máxima definición del haz generado y dando la posibilidad de perfilarlo creando diversas formas geométricas (circulares, triangulares, así como otras variables poligonales). Según su óptica se puede escoger entre apertura fija de 52° y apertura con diámetro variable de 18 a 34°, logrando haces de luz de diferentes proporciones.

## Diagrama polar

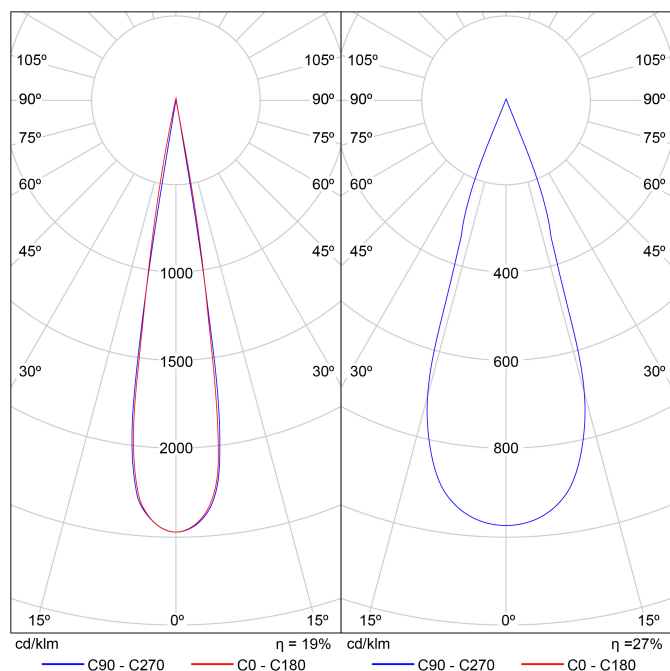

## Diagrama cónico

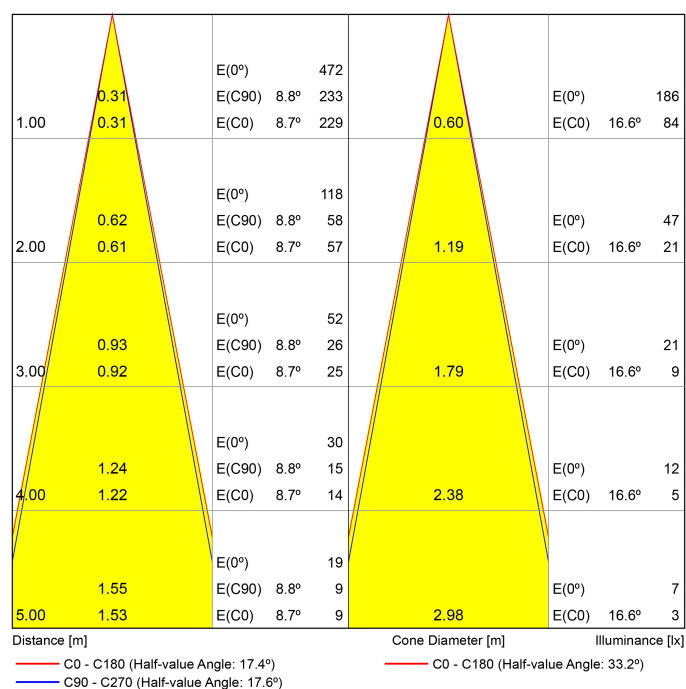

## Guía de instalación



<https://youtu.be/KnedJbKp7oo>

# Minimal Track

# ARKOSLIGHT

Minimal Track is a 24V low-voltage lighting system designed to create minimalist and highly configurable installations. On this page, you'll find the necessary components to configure your surface-mounted system.



Or use our online configurator to design your own custom product layout. The tool will guide you through the process and automatically calculate the required drivers and accessories. [Start your configuration →](#)



## Track & accessories - Surface mounting

Configure the shape of your track, add end caps and the required accessories, and finish the setup with the conductive strip (rubber cable).

### MINIMAL TRACK 24V

#### Profile 2m

A384-02-00- | N | WT |

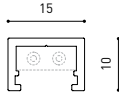

#### Corner 90° 1 Plane

A384-00-02- | N | WT |

Cable length = 35mm.

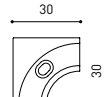

#### End Cap

A384-00-05- | N | WT |



#### Rubber Cable n x 1m

A384-00-01- | N |

n = Total length of System

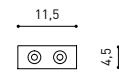

#### Corner 90° 1 Plane Rounded

A384-00-03- | N | WT |

Cable length = 35mm.

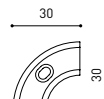

#### Connection Box

A384-00-06- | N | WT |

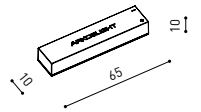

24V | Max. 4A |

#### Corner 90° 2 Planes

A384-00-04- | N | WT |

Cable length = 100mm.

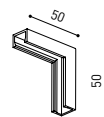

## Power Supply

Select your power supply, include a dimmer if needed, and explore the installation diagrams provided.

		P	V	D (A x B x C)
MINIMAL TRACK 24V Power Supply Box	A384-00-07-   NT   WT	40W	24V	280 x 30 x 24mm
	A384-00-08-   NT   WT	100W	24V	280 x 30 x 24mm
MINIMAL TRACK 24V Remote Power Supply	0434-01-37	60W	24V	180 x 52 x 30mm
	0433-10-22	100W	24V	295 x 43 x 30mm
220 V ~ 240 V ~				
MINIMAL TRACK 24V Remote Constant Voltage Dimmer	0433-01-32	DALI / Push	24V	181 x 42 x 20mm
	0433-01-35	CASAMBI	24V	72,6 x 30 x 18mm
24V	other DIM options please consult			

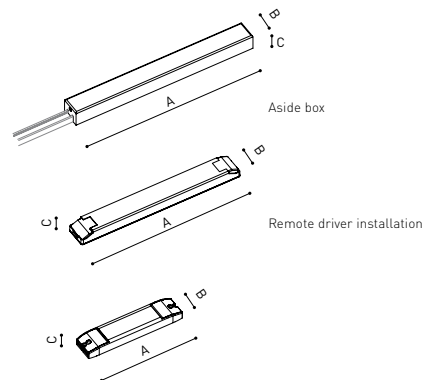

## Connection diagram:

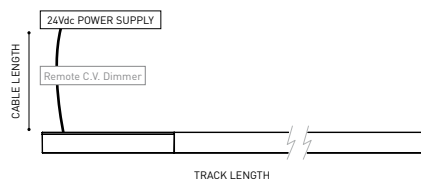

### DROP VOLTAGE TABLE

POWER (W)	CABLE SECTION (mm <sup>2</sup> )	CABLE LENGTH (m)			
		<5	<10	<20	<30
40	0,75	30	30	30	30
	1,5	30	30	30	30
60	0,75	30	30	20	10
	1,5	30	30	30	20
100	0,75	20	10	X	X
	1,5	20	20	10	X

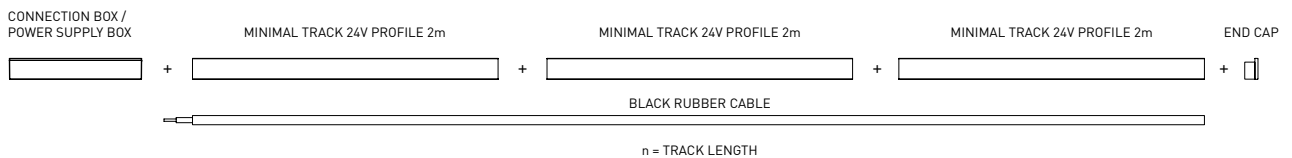

COLOUR | NT ■ RAL 9005 | WT □ RAL 9016 | N ■ RAL 9005 |

INSTALLATION GUIDE  
<https://youtu.be/KnedJbKp7oo>



# Minimal Track

# ARKOSLIGHT

Minimal Track is a 24V low-voltage lighting system designed to create minimalist and highly configurable installations. On this page, you'll find the necessary components to configure your trimless-mounted system.



Or use our online configurator to design your own custom product layout. The tool will guide you through the process and automatically calculate the required drivers and accessories. [Start your configuration →](#)

## Track & accessories - Trimless mounting

Configure the shape of your track, add end caps and the required accessories, and finish the setup with the conductive strip (rubber cable).

### MINIMAL TRACK 24V

#### Trimless Profile 2m

A467-02-00- | N |

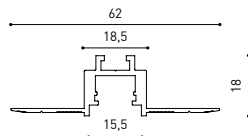

#### Trimless Rubber Cable n x 1m

A467-00-01- | N |

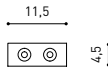

n = Total length of System

24V | Max. 4A |

#### Trimless Corner 90° 1 Plane

A467-00-02- | N |

Cable length = 140mm.

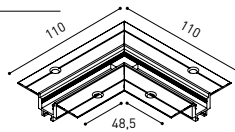

#### Trimless Corner 90° 2 Planes

A467-00-04- | N |

Cable length = 200mm.

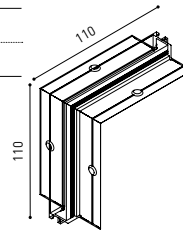

#### Trim. Corner 90° 1 Plane Connc.

A467-00-03- | N |

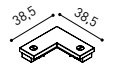

#### Trimless End Caps

A467-00-05- | N |

Two End Caps Included



#### Trimless Straight Joiner

A467-00-06

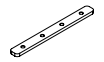

#### Trimless Connection Box

A467-00-07- | N |

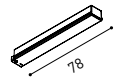

## Power Supply

Select your power supply, include a dimmer if needed, and explore the installation diagrams provided.

		P	V	D (A x B x C)
MINIMAL TRACK 24V Remote Power Supply	0434-01-37	60W	24V	180 x 52 x 30mm
	0433-10-22	100W	24V	295 x 43 x 30mm

220 V ~  
240

			V	D (A x B x C)
MINIMAL TRACK 24V Remote Constant Voltage Dimmer	0433-01-32	DALI / Push	24V	181 x 42 x 20mm
	0433-01-35	CASAMBI	24V	72,6 x 30 x 18mm

24V | other DIM options please consult

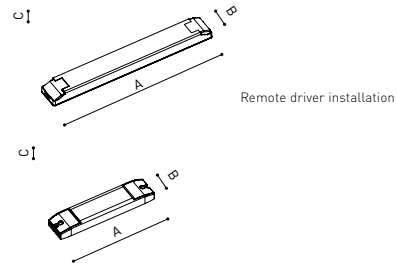

## Connection diagram:

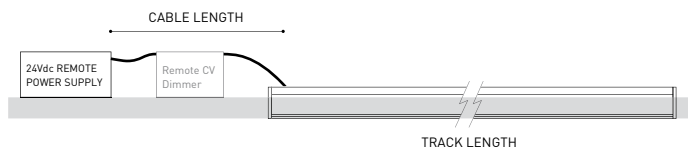

### DROP VOLTAGE TABLE

POWER (W)	CABLE SECTION (mm <sup>2</sup> )	CABLE LENGTH (m)			
		<5	<10	<20	<30
40	0,75	30	30	30	30
	1,5	30	30	30	30
60	0,75	30	30	20	10
	1,5	30	30	30	20
100	0,75	20	10	X	X
	1,5	20	20	10	X

Reduce 5 meters per each 'Corner 90° 1 Plane CONNECTOR' used.

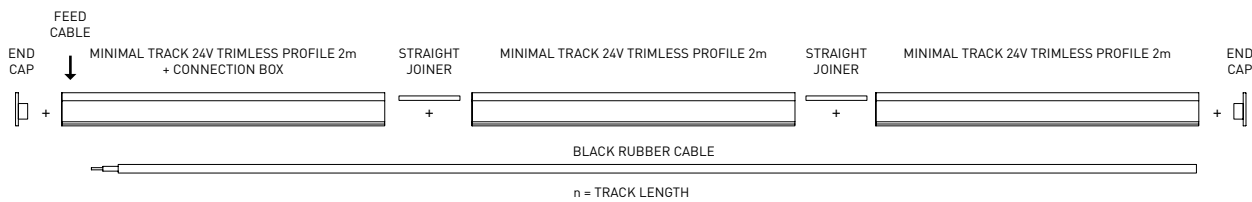

COLOUR | NT ■ RAL 9005 | WT □ RAL 9016 | N ■ RAL 9005 |

INSTALLATION GUIDE  
<https://youtu.be/KnedJbKp7oo>



# Minimal Track

# ARKOSLIGHT

Minimal Track is a 24V low-voltage lighting system designed to create minimalist and highly configurable installations. On this page, you'll find the necessary components to configure your suspension-mounted system.



Or use our online configurator to design your own custom product layout. The tool will guide you through the process and automatically calculate the required drivers and accessories. [Start your configuration →](#)

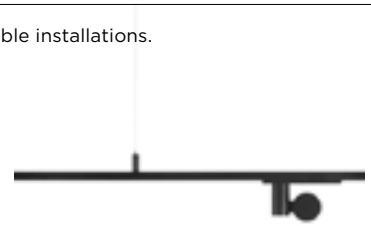

## Track & accessories - Suspension mounting

Configure the shape of your track, add end caps and the required accessories, and finish the setup with the conductive strip (rubber cable).

### MINIMAL TRACK 24V Suspension

**Profile 2m**  
A384-02-00- | N | WT |

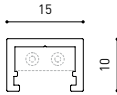

**Rubber Cable n x 1m**  
A384-00-01- | N |

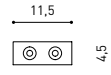

**Suspension Straight Joiner**  
A400-00-02- | N | WT |



**Profile 2m Initial feed kit**  
A400-02-10- | N | WT |

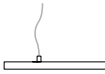

24V | Max. 4A | III

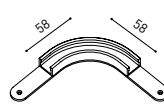

**Suspension Kit**  
A400-02-04- | N | WT |

Max distance between suspension kits = 100 cm.

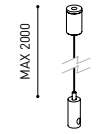

**Profile 2m Middle feed kit\***  
A400-02-20- | N | WT |

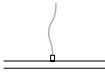

**Corner 90°**  
A400-00-03- | N | WT |

Cable length = 85mm.

**Suspension End Caps**  
A400-00-05- | N | WT |

Two End Caps Included.



\* Unidirectional Middle Feed.

## Power Supply

Select your power supply, include a dimmer if needed, and explore the installation diagrams provided.

		P	V	D (A x B x C)	
MINIMAL TRACK 24V Susp Power Supply Box	NO DIM	A400-00-06-   NT   WT	40W	24V	280 x 30 x 36mm
		A400-00-07-   NT   WT	100W	24V	280 x 30 x 36mm
MINIMAL TRACK 24V Remote Power Supply	NO DIM	0434-01-37	60W	24V	180 x 52 x 30mm
		0433-10-22	100W	24V	295 x 43 x 30mm

220V-  
240V

MINIMAL TRACK 24V Remote Constant Voltage Dimmer		0433-01-32	DALI / Push	24V	181 x 42 x 20mm
		0433-01-35	CASAMBI	24V	72,6 x 30 x 18mm

24V | other DIM options please consult

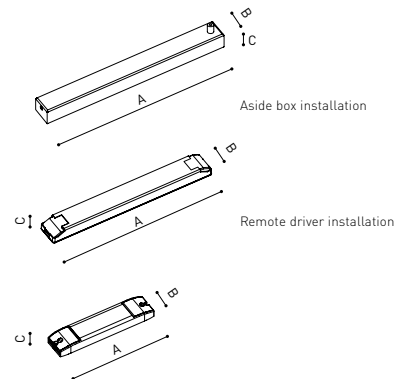

## Connection diagram:

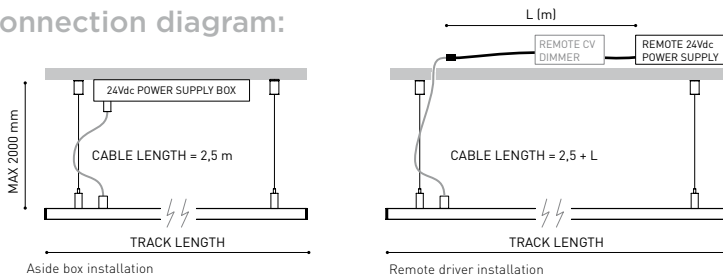

### DROP VOLTAGE TABLE

POWER (W)	CABLE SECTION (mm <sup>2</sup> )	CABLE LENGTH (m)			
		<5	<10	<20	<30
40	0,75	30	30	30	30
	1,5	30	30	30	30
60	0,75	30	30	20	10
	1,5	30	30	30	20
100	0,75	20	10	X	X
	1,5	20	20	10	X

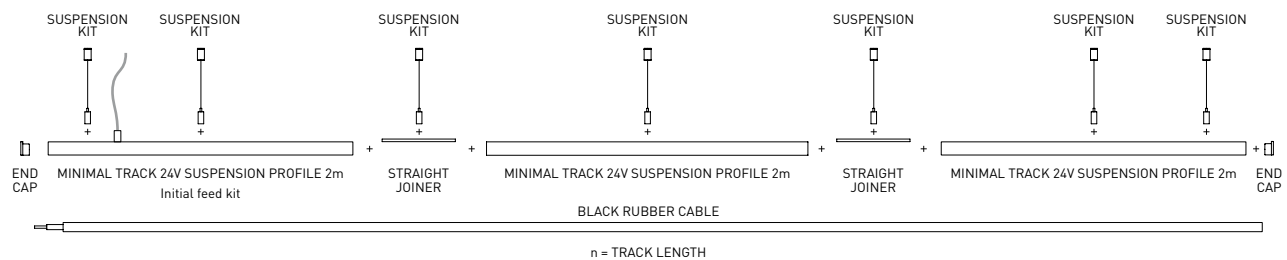

COLOUR | NT ■ RAL 9005 | WT □ RAL 9016 | N ■ RAL 9005 |



Model	Coaxial Trimless
Reference	A023-00-03-   W   N
Colour	W <input type="checkbox"/> RAL 9016   N <input checked="" type="checkbox"/> RAL 9005
Category	Accessories



## Dimmensional drawing

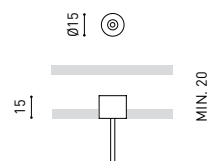

### Accesorio para cable trimless

Wire Trimless Accessory es una colección de accesorios que permiten instalar los tensores y cables de las luminarias de suspensión de Arkoslight directamente desde el techo, sin ningún florón ni anclaje visto. Se logra así una aplicación minimalista y visualmente limpia en el espacio.

Con los Wire Trimless Accessory los elementos adyacentes al techo del producto estándar (florones, anclajes, cajas de driver...) se esconden a través de una simple aplicación de empotramiento.

Wire Trimless Accessory reduce el peso visual de la instalación y genera una estética extremadamente minimalista. Los cables nacen desde el material en el techo como parte de la estructura. Este detalle genera una disposición mucho más pura y esencial, especialmente, en composiciones de varias unidades.



INSTALLATION GUIDE

[https://youtu.be/sa\\_xAgj4ji4](https://youtu.be/sa_xAgj4ji4)



#### PRODUCT

Model	Trimless Tool <b>D20 X D52 MM</b>
Reference	A478-00-01
Category	Accessories

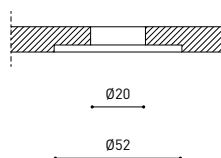
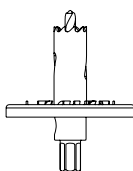



Fuente de luz (LED) reemplazable por un profesional autorizado  
 Replaceable (LED only) light source by an authorized professional.  
 Source lumineuse (LED) remplaçable par un professionnel agréé  
 Sorgente luminosa (LED) sostituibile da parte di un professionista autorizzato  
 Austauschbare (LED) Lichtquelle durch einen autorisierten Fachmann



Equipo de control reemplazable por un profesional autorizado  
 Replaceable control gear by an authorized professional  
 Dispositif de commande remplaçable par un professionnel agréé  
 Alimentatore sostituibile da parte di un professionista autorizzato  
 Auswechselbares Betriebsgerät durch autorisierten Fachmann

## Instrucciones para el final de vida y la eliminación de los componentes:

### Instructions on end-of-life and component disposal:

### Instructions pour la gestion des composants en fin de vie et leur mise au rebut :

### Istruzioni per il fine vita e lo smaltimento dei componenti:

### Anweisungen zur entsorgung der Leuchtenkomponenten:



Interrumpir la alimentación del aparato  
 Cut the power supply to the luminaire  
 Couper l'alimentation du luminaire  
 Interrompere l'alimentazione dell'apparecchio  
 Stromversorgung der Leuchte unterbrechen



Quitar la(s) fuente(s) de luz para el desecho  
 Remove light source(s) for disposal  
 Retirer la (les) source(s) lumineuse(s) pour l'élimination  
 Rimuovere la/le sorgente/e di luce per lo smaltimento  
 Lichtquelle(n) zur Entsorgung entfernen



Quitar la batería para el desecho  
 Remove the battery for decommissioning  
 Retirer la batterie pour sa mise au rebut  
 Rimuovere la batteria per la dismissione  
 Die Batterie ordnungsgemäß entsorgen



Quitar el equipo de control para el desecho  
 Remove control gear for disposal  
 Retirer le dispositif de commande pour l'élimination  
 Rimuovere l'alimentatore per lo smaltimento  
 Betriebsgerät zur Entsorgung ausbauen



Enviar los materiales a un centro de recogida RAEE  
 Send the materials to a WEEE collection centre  
 Envoyer les matériaux dans une déchetterie DEEE  
 Inviare i materiali ad un centro di raccolta RAEE  
 Die Materialien in einem WEEE-Zentrum entsorgen

